

**Canon**

**RF**

**35mm F1.4 L VCM**

**Instructions**

**ENG**

# Thank you for purchasing a Canon product.

Canon RF35mm F1.4 L VCM is a wide angle lens for use with EOS R series cameras.

- “VCM” stands for Voice Coil Motor.

## Conventions used in these instructions



Warning to prevent lens or camera malfunction or damage.



Supplementary notes on using the lens and taking pictures.

## Camera Firmware and Camera Applications

Please use the latest versions of firmware and applications with the camera in use. For details on whether the firmware and applications in use are the latest version or not, and for details on updating them, please check the Canon website.



If the camera's\* firmware is not a compatible version, the following limitations will apply.

- Magnified view functionality is not available.
- In some cases, the camera malfunction may occur.

\* Applies to the following camera models:  
EOS R and EOS RP

# Safety Precautions

Precautions to ensure that the camera is used safely. Read these precautions thoroughly. Make sure all details are observed in order to prevent risks and injury to the user and other people.



## Warning

Details pertaining to risks that may result in death or serious injury.

- **Do not look directly at the sun or other strong light sources through a lens.** This may result in loss of sight.
- **Do not leave a lens in the sun without the lens cap attached.** The lens may concentrate entering sunlight and cause a malfunction or fire.



## Caution

Details pertaining to risks that may result in injury or damage to other objects.

- **Do not leave the product in places exposed to extremely high or low temperatures.** The product may cause burns or injury when touched.
- **This product emits low level magnetic flux.** If you use an implantable cardiac pacemaker or other medical device and feel abnormalities, please keep away from this product and consult your doctor.

# General Precautions

## Handling Precautions

- Do not leave the product in excessive heat such as in a car in direct sunlight. High temperatures can cause the product to malfunction.
- If the lens is taken from a cold environment into a warm one, condensation may develop on the lens surface and internal parts. To prevent condensation in this case, first put the lens into an airtight plastic bag before taking it from a cold to warm environment. Then take out the lens after it has warmed gradually. Do the same when taking the lens from a warm environment into a cold one.
- When the lens is not attached to the camera or the power switch of the camera is in the off status when the lens is attached, shaking the lens may cause the internal lens group to shift and noise may occur, but this is not a malfunction. Although the internal lens group shifts due to vibration such as when the lens is carried, this will not affect aspects such as performance.
- In order to optimize aperture control, there are occasions in which the aperture blades will move during focusing, even when the aperture value is set for aperture-priority AE or manual exposure, etc.
- Please also read any lens related handling precautions listed in your camera's instruction manual.

## Shooting Precautions

- Focus again after recovering from the auto power off status.
- To maintain the focus position in the shooting-ready status, set [Auto power off] to [Disable] on the camera.

This device complies with Part 15 of the FCC Rules.

Operation is subject to the following two conditions: (1) This device may not cause harmful interference, and (2) this device must accept any interference received, including interference that may cause undesired operation.

Do not make any changes or modifications to the equipment unless otherwise specified in the instructions. If such changes or modifications should be made, you could be required to stop operation of the equipment.

This equipment has been tested and found to comply with the limits for a class B digital device, pursuant to part 15 of the FCC Rules. These limits are designed to provide reasonable protection against harmful interference in a residential installation. This equipment generates, uses and can radiate radio frequency energy and, if not installed and used in accordance with the instructions, may cause harmful interference to radio communications.

However, there is no guarantee that interference will not occur in a particular installation. If this equipment does cause harmful interference to radio or television reception, which can be determined by turning the equipment off and on, the user is encouraged to try to correct the interference by one or more of the following measures:

- Reorient or relocate the receiving antenna.
- Increase the separation between the equipment and receiver.
- Connect the equipment into an outlet on a circuit different from that to which the receiver is connected.
- Consult the dealer or an experienced radio/TV technician for help.

# Nomenclature

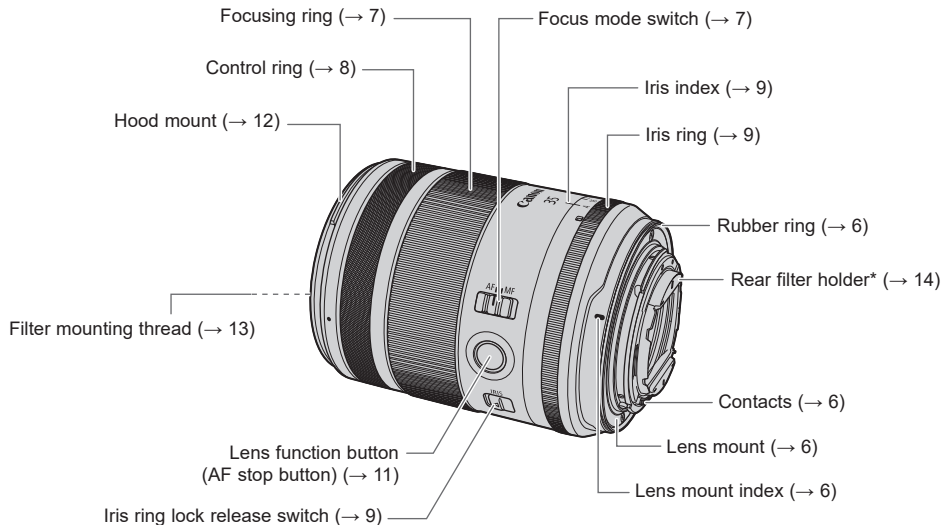

\* Included with the lens. It is not attached to the lens at the time of purchase.

● For detailed information, reference page numbers are provided in parentheses (→ \*\*).

# 1. Attaching and Detaching the Lens

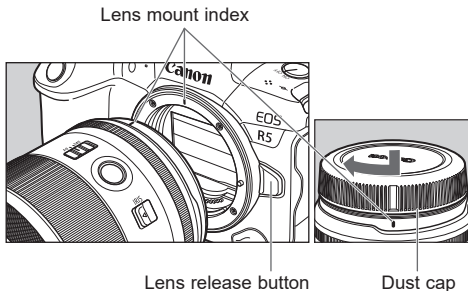

## Attaching the Lens

Align the lens mount indexes of the lens and camera, and turn the lens clockwise until you hear a click.

## Detaching the Lens

Turn the lens counterclockwise while pressing the camera's lens release button. Detach the lens once it has stopped turning.

Please refer to the camera's instructions for details.



- Set the camera's power switch to OFF when attaching or detaching the lens.
- Attach the lens cap before detaching the lens from the camera.
- After detaching the lens, place the lens with the rear end up and attach the dust cap to prevent the lens surface and contacts from getting scratched. Make sure the lens and dust cap mount indexes are aligned when attaching the dust cap.
- Contacts that are scratched, soiled, or have fingerprints on them may result in faulty connections or corrosion, which may lead to malfunctions. If the contacts get soiled, clean them with a soft cloth.
- The lens mount has a rubber ring to improve dust-resistance and water-resistance performance. This rubber ring may cause friction marks to appear around the camera's lens mount, although this will have no effect on usage.



- Rubber rings can be replaced at Canon Service Center. (chargeable)

## 2. Setting the Focus Mode

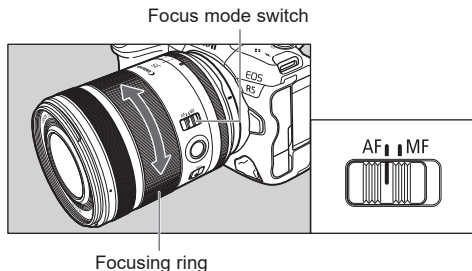

To shoot in autofocus (AF) mode, set the focus mode switch to AF.

To use only manual focusing (MF), set the focus mode switch to MF, and focus by turning the focusing ring.

● Quickly turning the focusing ring may result in delayed focus.

- The lens' focusing ring is electronic.
- With a camera capable of electronic full-time manual focus, manual focusing is always possible while the camera is operable. However, this requires a change in camera settings.
- When AF operation is set to One-Shot AF, manual focus is possible after autofocusing has been completed by continuing to press the shutter button halfway (electronic manual focus function). However, this requires a change in camera settings.
- When movie recording, the AF speed will be slower than the still photo shooting mode. It is possible to adjust the AF speed on the camera by setting Movie Servo AF to [Enable].

Please refer to the camera's instructions for details.



### 3. Control Ring

The control ring can be assigned the functions that are commonly used with cameras, such as shutter speed and aperture settings.

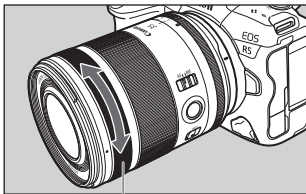

Control ring

The click action of the control ring allows you to have a sense of how much it is being turned. Please refer to the camera's instructions for details on how to use the control ring.

- There are cases in which the sound of control ring operations may be recorded when shooting movies.

- The clicking sensation of the control ring can be removed by the Canon Service Center. (chargeable)
- The focus ring can be used as the control ring by changing the camera settings\*. However, when the focus ring is used as the control ring, the original control ring operation will be disabled. Please refer to the camera's instructions for details.

\* Excluding EOS R, RP, Ra, R5, R5C, and R6.

## 4. Manual/ Auto Aperture Operation

The aperture value can be set using the iris ring. At the time of shipment, it is set to auto aperture operation.

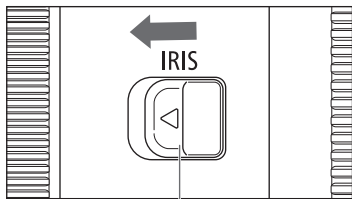

Iris ring lock release switch

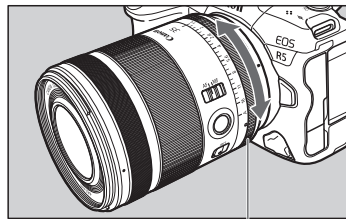

Iris ring

### Manual aperture operation

- 1 While sliding the iris ring lock release switch in the direction of the arrow, turn the iris ring to match the iris index between 1.4 and 16.
- 2 Turn the iris ring to set the aperture.

### Auto aperture operation

- 1 While sliding the iris ring lock release switch in the direction of the arrow, turn the iris ring to match the iris index with A.
- 2 Aperture is determined by the command signal from the camera.

## Manual/ Auto Aperture Operation

- For manual aperture operation with the Iris Ring and when shooting movies, the aperture value changes in 1/32 steps, regardless of the camera settings. Consequently, the actual aperture value when shooting movies may vary from the aperture value displayed on the camera.
  - Some cameras \*1 \*2, have the following limitations.
    - The iris ring cannot be used to set the aperture value when shooting still images.
    - During movie shooting, when using the iris ring operation, focusing on a subject by autofocus may be difficult. In addition, the aperture value displayed on the camera may differ from the actual aperture value.
- \*1 EOS R, RP, Ra, R3, R5, R6, R6 Mark II, R7, R8, R10, R50, R100
- \*2 EOS R5C is limited only when shooting still images.

## 5. Lens Function Button (AF Stop Button)

In the default settings, the lens function button serves as a AF stop button. You can assign different functions to the button from the [Customize buttons] section of the camera. Please refer to the camera's instructions for details.

Lens function button  
(AF stop button)

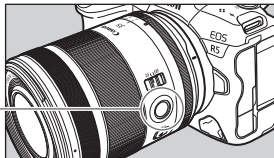

### Use as a AF stop button

During autofocus operation, you can press an AF stop button to temporarily pause autofocus, and then release the button to resume.

Press an AF stop button to maintain a focusing distance or to avoid focus search.

Press the shutter button while holding down an AF stop button to shoot at that focusing distance.

- Useful when autofocus is operating mostly in Servo AF.

## 6. Hood

The custom lens hood reduces unwanted light that causes flare and ghosting and protects the front of the lens from rain, snow, and dust.

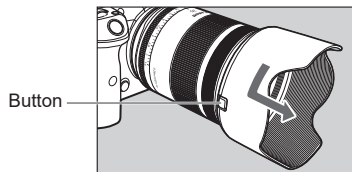
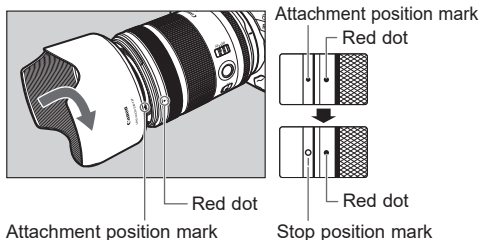

### Attaching the Hood

Align the red attachment position mark on the hood with the red dot on the front of the lens, and then turn the hood in the direction of the arrow until you hear a click.

### Detaching the Hood

Keep your finger pressed down on the button located on the side of the hood, and then turn the hood in the direction of the arrow until the attachment position mark on the hood is aligned with the red dot on the front of the lens to detach it.

The hood can be reverse-mounted on the lens for storage.

- If the hood is not attached properly, vignetting (darkening of the perimeter of the picture) may occur.
- Grasp and turn the base of the hood when attaching and detaching it. There are cases in which it may become deformed if the hood is turned with it grasped near to the rim.

## 7. Filters (Sold separately)

With this lens, filters can be attached to the front and back of the lens.

### When using threaded filters

You can attach filters (ø67) to the filter mounting thread on the front of the lens.

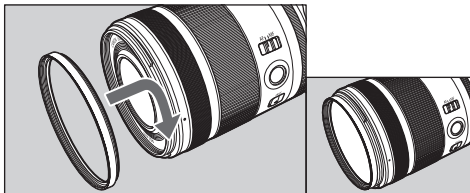

- Only one filter may be attached.
- If you need a polarizing filter, use the Canon Circular Polarizing Filter PL-C B.
- Detach the hood when adjusting the polarizing filter.

## Filters (Sold separately)

### When using sheet type filters

A rear filter holder is included with this lens.

Download the filter template files, print them out, then lay the filter over the template and cut to match. Then insert the filter in the rear filter holder.

#### 1 Cut the filter to match the shape of the filter template appropriately.

- Download the filter template file (PDF).
- Print the filter template out at full size (100%), and use it as the template to cut out the filter.
- The templates on this page are printed at full size, so can also be used. The filter template file is the same as this figure.

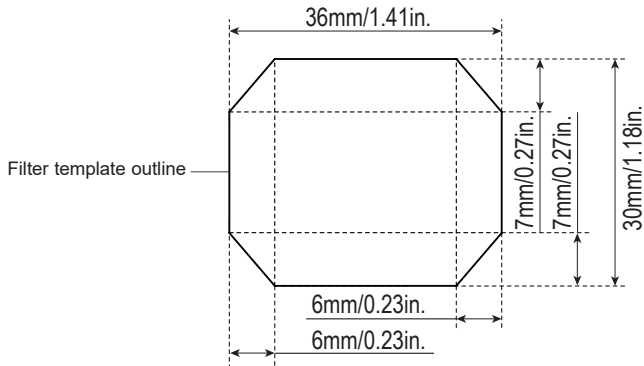

## Filters (Sold separately)

- Only one filter with a thickness of 0.2 mm/0.008 in. or less may be used.
- When printing the template, make sure that the illustration size remains the same. Check that the printed-out size is the same as the measurements shown in the illustration.
- Cut along the middle of the lines printed on the filter template. Any deviation from the template line width can cause the following issues.
  - Note 1: If you cut inside the lines, light will come in around the edges of the filter, preventing it from working fully. In particular, there can be differences with exposure and color patches in the corners.
  - Note 2: If you cut outside the lines, it may not fit in the rear filter holder, or the filter corners could contact the camera, damaging the camera or filter.



## Filters (Sold separately)

- 2 Insert the filter into the rear filter holder in the direction of the arrow.

Projections Filter indexes

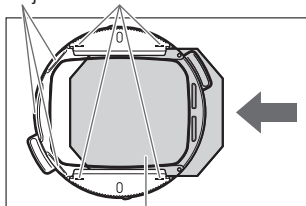

Filter

- 3 Check the filter after insertion.

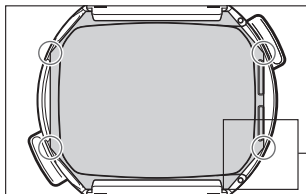

- ① Check the insertion of the filter (is it within the rear filter holder frame?, are the 4 corners sticking outside the holder?).

- If the filter sticks outside the rear filter holder, cut the filter.

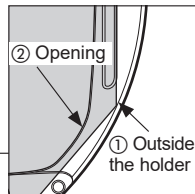

- ② Check the insertion of the filter (does the filter cover the opening of the rear filter holder?).

## Filters (Sold separately)

Attach the rear filter holder to the back of the lens.

- 4 Align the attachment position mark on the lens body with the index on the rear filter holder.
- 5 Turn in the direction of the arrow until the rear filter holder index aligns with the stop position mark on the lens body.

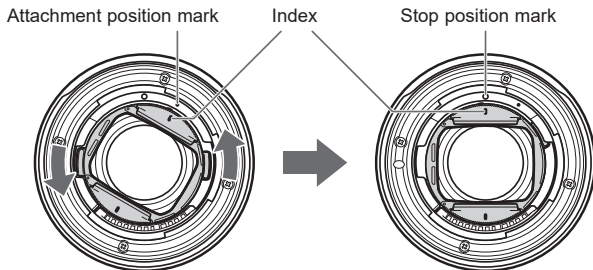

## Filters (Sold separately)

- Take some test shots before shooting to check that the filter is working over the entire image.
- Check that the filter is correctly inserted before shooting.
- When the rear filter holder is attached to the lens body, ghosting may occur depending on shooting conditions. When not using the rear filter, remove the rear filter holder from the lens body.
- When removing the filter and rear filter holder, remove by reversing the order of attaching.

# Specifications

|                                 |   |
|---------------------------------|---|
| <b>Focal Length/Aperture</b>    | 35mm f/1.4                                    |
| <b>Lens Construction</b>        | 11 groups, 14 elements                        |
| <b>Maximum Aperture</b>         | f/1.4   |
| <b>Minimum Aperture</b>         | f/16  |
| <b>Angle of View</b>            | Horizontal: 54°, Vertical: 38°, Diagonal: 63° |
| <b>Min. Focusing Distance</b>   | 0.28 m/0.92 ft.                               |
| <b>Max. Magnification</b>       | 0.18x   |
| <b>Field of View</b>            | Approx. 195 x 130 mm/7.68 x 5.12 in.          |
| <b>Filter Diameter</b>          | 67mm (in front)                               |
| <b>Max. Diameter and Length</b> | Approx. 76.5 x 99.3 mm/3.01 x 3.91 in.        |
| <b>Weight</b>                   | Approx. 555 g/19.58 oz.                       |
| <b>Hood</b>                     | EW-73F*                                       |
| <b>Lens Cap</b>                 | E-67 II*                                      |
| <b>Lens Dust Cap</b>            | Lens Dust Cap RF*                             |
| <b>Case</b>                     | LP1219*                                       |

\* Included with the lens, but can be purchased separately.

## Specifications

- The lens length is measured from the lens mount surface to the front end of the lens.  
Add 24.2 mm/0.95 in. when including the lens cap and dust cap.
- The maximum diameter, length and weight listed are for the lens itself only.
- Close-up Lens 250D/500D cannot be attached because there is no size that fits the lens.
- You cannot use extenders.
- Multiple exposure shooting is not possible when using this lens on certain cameras\*.  
\* EOS R, RP, Ra, R5, R5C, R6
- All data listed is measured according to Canon standards.
- Product specifications and appearance are subject to change without notice.

**Canon**